

THE ULTIMATE POWERSTACK® SYSTEM

FACTORY-BUILT CHIMNEY AND GREASE DUCT SYSTEMS



ENERVEX® 
VENTING DESIGN SOLUTIONS

T: +1 800.255.2923 · www.enervex.com

A UNIQUE STACK SYSTEM

ENERVEX has reinvented the way you design and install chimney systems: The "One-Type-Fits-All" prefabricated stainless steel chimney. PowerStack!

The PowerStack is a "state-of-the-Art", multi-application chimney exhaust system designed to convey gases, particles, fumes, smoke, grease and products of combustion from a wide range of equipment.

POWERSTACK IS THE ONLY CHIMNEY THAT ALLOWS YOU TO MIX APPLIANCE CATEGORIES IN A SINGLE CHIMNEY SYSTEM. IT PROTECTS THE FUTURE.

ENERVEX ADVANTAGES



ONE-STOP-DESIGN

Products built to work together guarantees seamless integration; single-supplier responsibility eliminates guesswork and blame game.



DESIGNER FRIENDLY

For any building type, for any appliance type. Proven solutions that deliver performance every time. And all components are UL or ETL listed.



INSTALLER FRIENDLY

Perfect fit for any chimney system. Simple and seamless installation with "plug-and-play" makes integration easy.



PERFECT DRAFT

Consistent performance and reliability. Optimizes equipment performance and fuel efficiency.



File No. MH61178

UL LISTINGS AND APPROVAL

PowerStack "One-Type-Fits-All" chimney system has the listings and certifications to support it:

UL 17, UL 103, UL 1738, UL 1777, UL 1978, UL 2561, ULC-S635, ULC-S636, ULC-S662, ULC/ORD-C959 and complies with NFPA 37, NFPA 54, NFPA 211, CSA B149

APPLICATIONS

The use of PowerStack is not limited to boilers and water heaters. The product is also tested and listed for and can be used with:

**GENERATORS, ENGINE EXHAUST,
FUME VENTING, GREASE DUCT,
PIZZA OVEN CHIMNEY, BBQ CHIMNEY/
EXHAUST, DISHWASHER EXHAUST**

BOILERS/WATER HEATERS

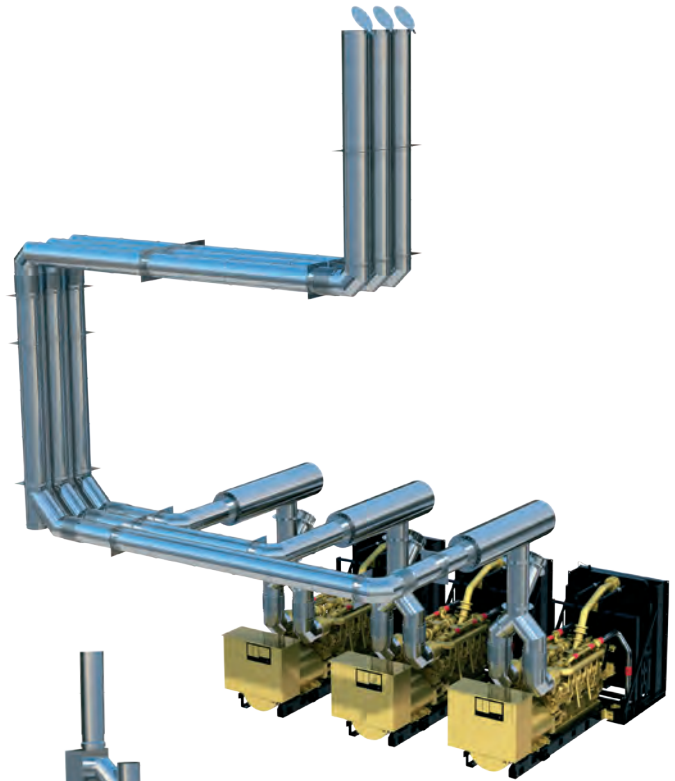

GENERATORS

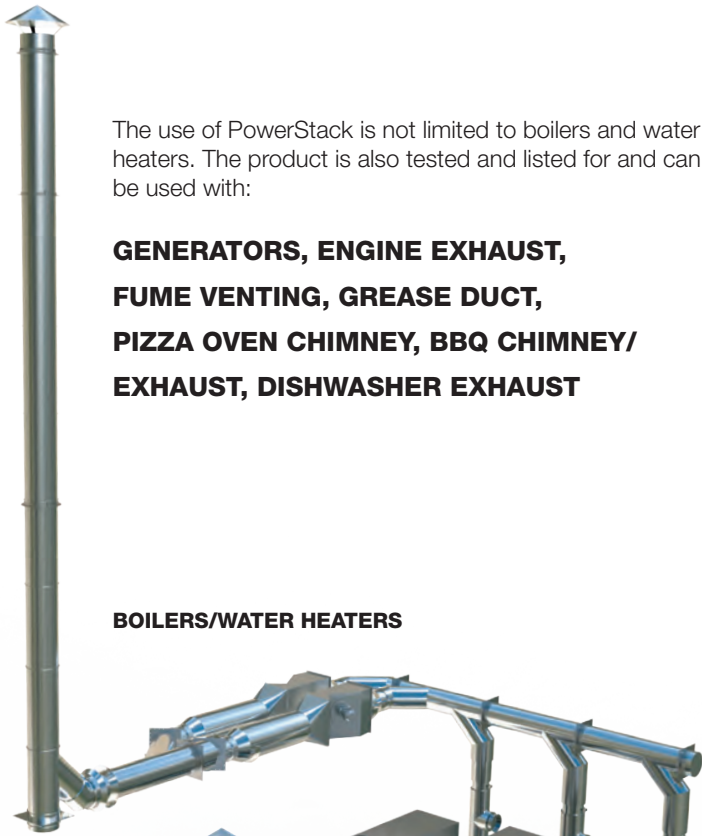

RESTAURANTS KITCHEN HOOD EXHAUST

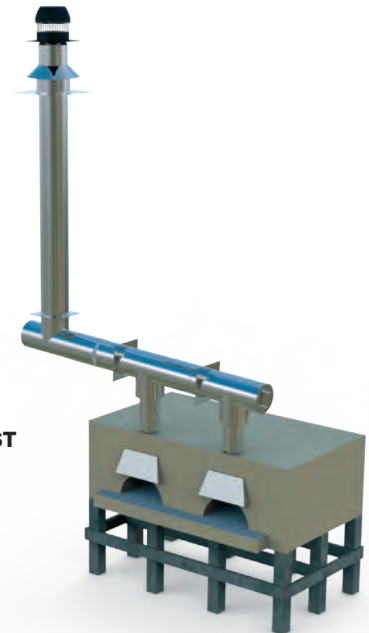

PIZZA OVENS

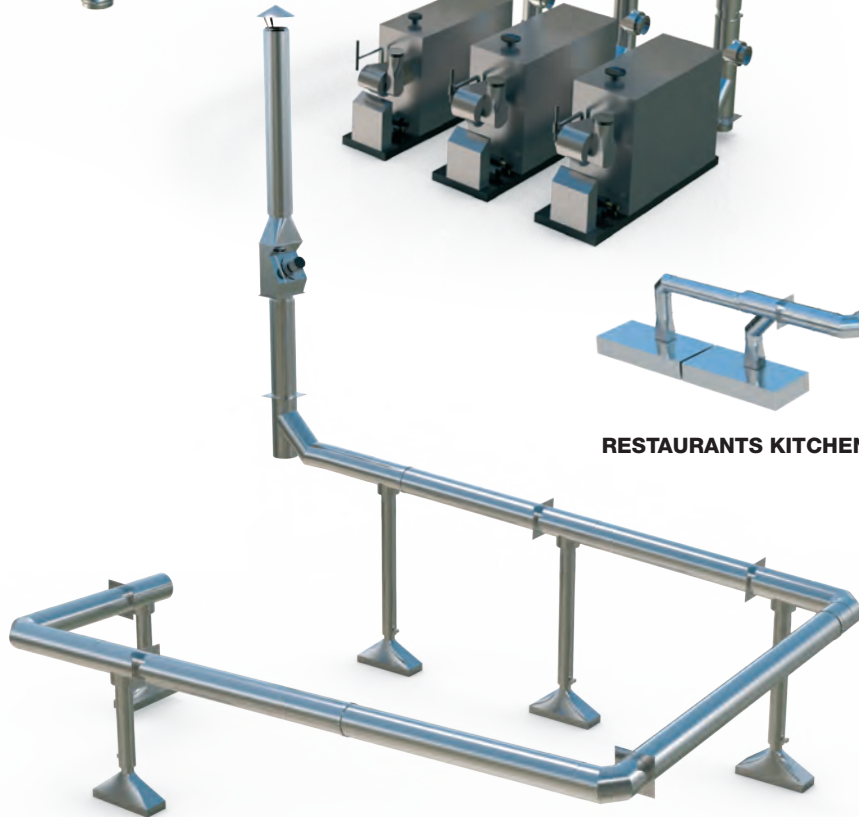

FUME HOOD/PROCESSHOODS

POWERSTACK® – THE PRODUCTS WITH A UNIQUE A

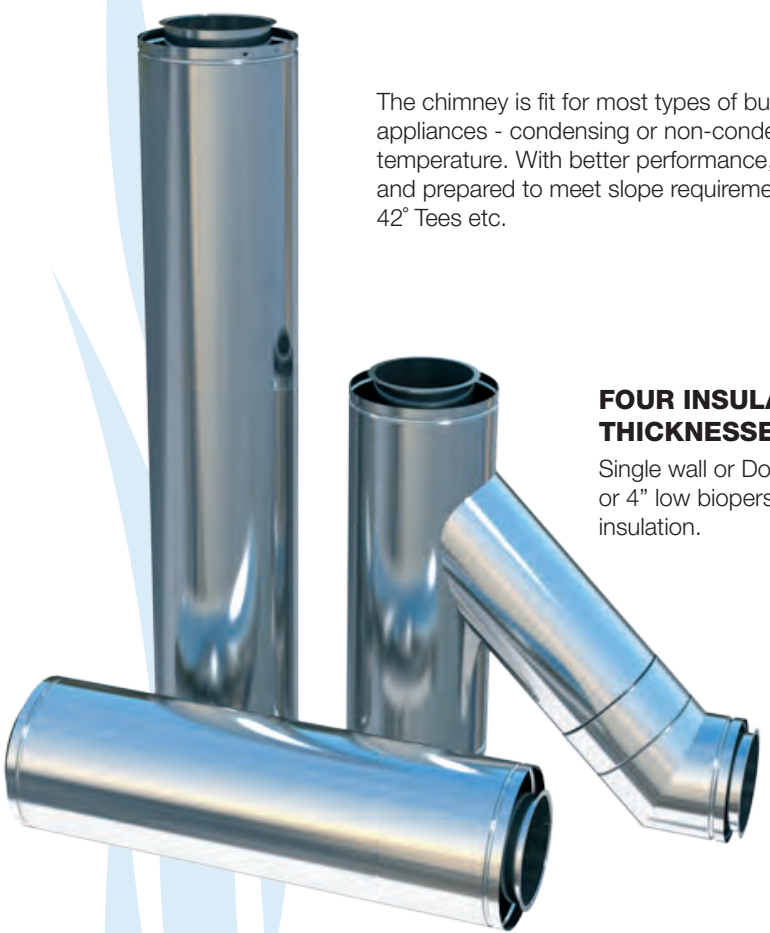

The chimney is fit for most types of building, applications, appliances - condensing or non-condensing, low or high temperature. With better performance, easier installation – and prepared to meet slope requirements with 3° elbows, 42° Tees etc.

FOUR INSULATION THICKNESSES

Single wall or Double-Wall with 1", 2" or 4" low biopersistant fiber Insulfrax insulation.

AND POWERSTACK IS THE BEST-LOOKING CHIMNEY SYSTEM WITH ITS GLOSSY FINISH

SLOPING DESIGN POSSIBLE WITH STANDARD COMPONENTS
"SAW-TOOTH" DESIGN POSSIBLE FOR LOW CLEARANCE

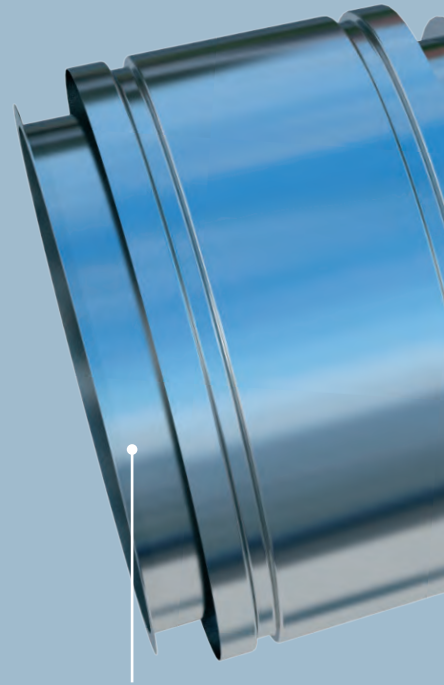

CORROSION RESISTANCE

The special stainless steel 316L-PCM has superior corrosion resistance.

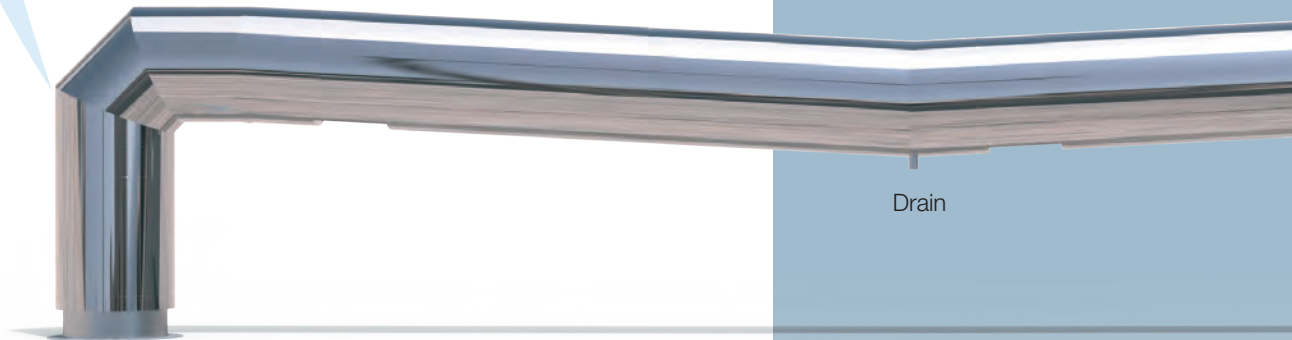

Drain

ASSEMBLY SYSTEM

PowerStack features a patent-pending male/female gasketed joint design that makes it very strong, pressure and liquid tight and virtually eliminates the risk of leakage, when properly installed.

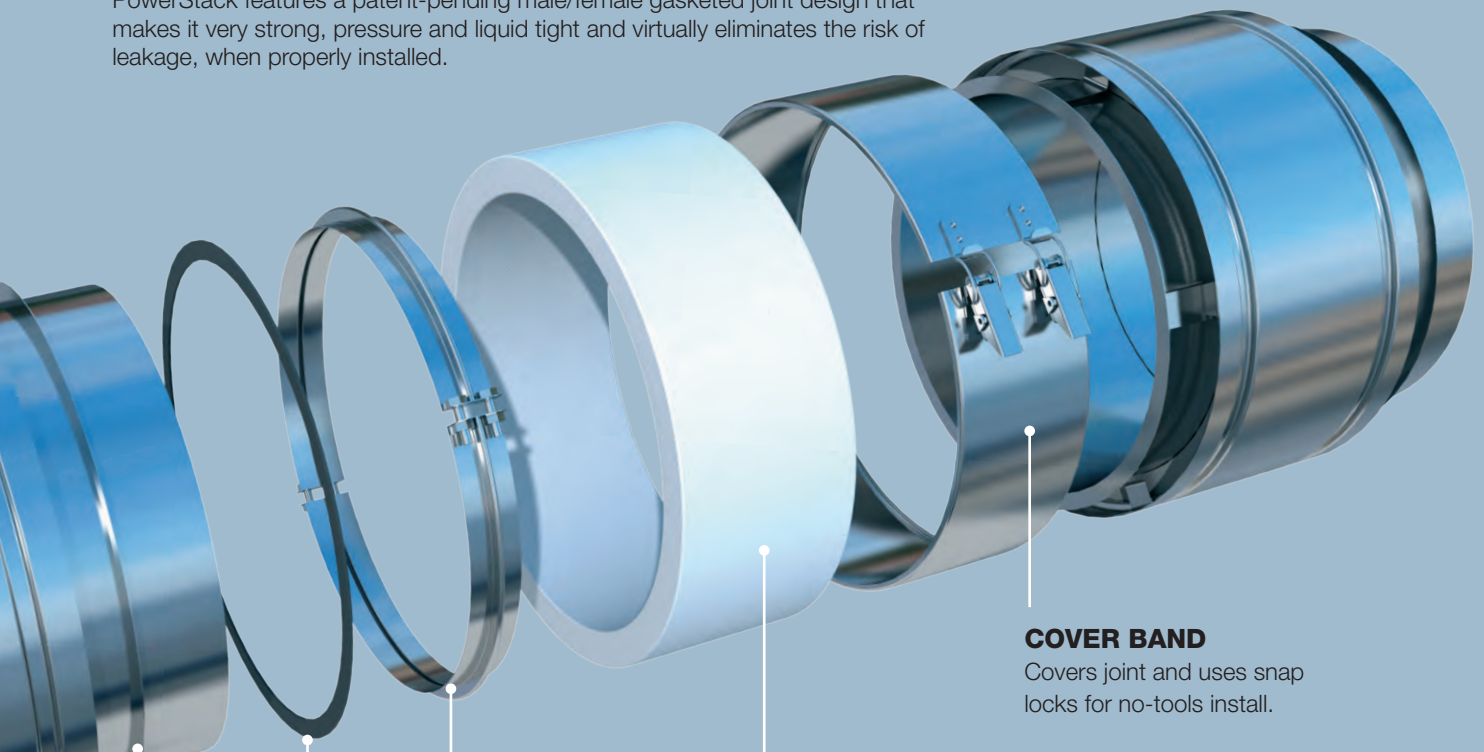

1/2" FLANGE

GRAPHITE GASKET FOR A SUPERIOR SEAL

Only graphite is extremely heat resistant and inert to most gases and corrosive liquids – and won't break down and leak over time.

U-BAND

Double half-rings provide a snug fit without sealant.

INSULATION

Single wall or Double-Wall with low biopersistant fiber Insulfrax insulation.

COVER BAND

Covers joint and uses snap locks for no-tools install.

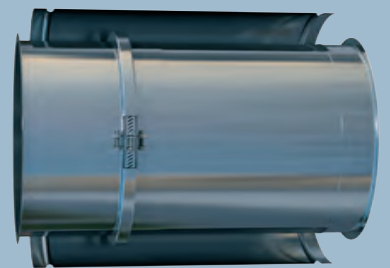

ADJUSTABLE LENGTHS

The industry's only UL-listed adjustable length with a 1400°F temperature rating and a 60 inch WC pressure rating!

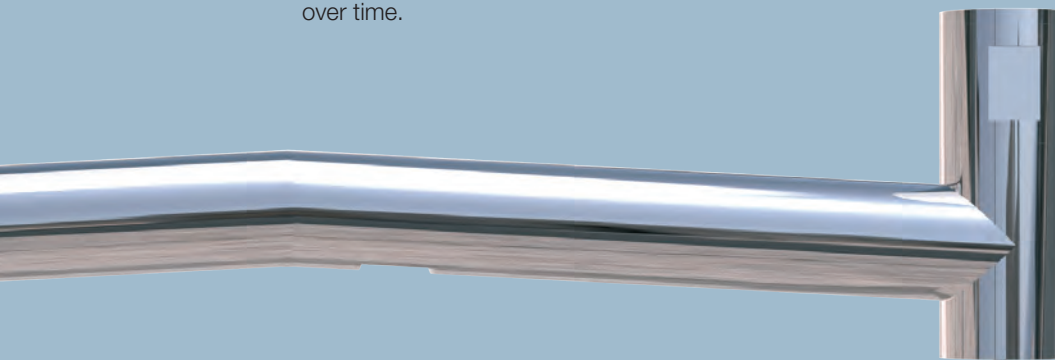

Drain



AN INTEGRATED VENTING SOLUTION

PowerStack is "The Ultimate Venting Solution" and integrates all the accessories and equipment needed to complete a project, from boiler outlet to chimney termination. One-stop design with a guaranteed fit. And the proper UL listings on all components, so the solution becomes a LISTED SYSTEM.



BELLOWS

High temperature vibration isolators and expansion lengths for installation at the engine or generator manifold. Or in the chimney system itself.

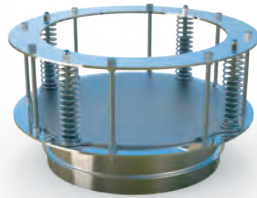

PRESSURE RELIEF VALVES

For use with engine and generator exhaust. Installs in a 90° Tee or 45° Tee Lateral Tee. With integrated 1/2" flanges eliminating the need for ANSI flanges.



INLINE ACCESS DOORS

Facilitates inspection and cleaning. Can be installed horizontally or vertically. With graphite gasket.



3° ELBOWS, 87° ELBOWS & TEES

A selection of 3°, 42°, 87° elbow and tee components used to design proper slope in condensing applications.

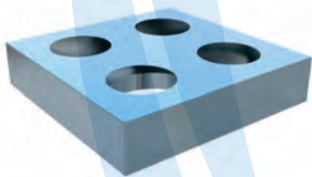

PLENUM BOXES

Used with exterior multiple fan installations for added performance or for redundancy. Can be fitted with isolation dampers.

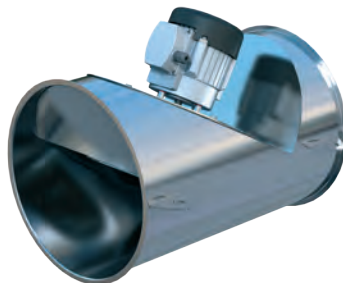

MECHANICAL DRAFT FANS

For designs that require inline or termination mechanical draft due to design challenges or to optimize a chimney system.

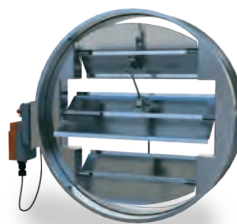

DAMPERS

Automatic dampers and balancing baffles for installation in appliance connectors to close the flow and/or balance the draft.

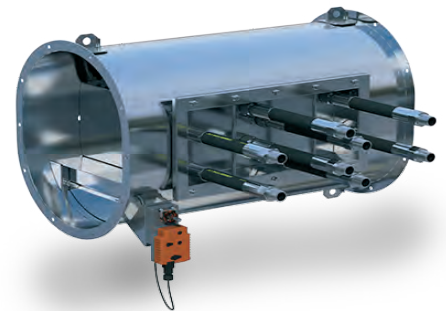

ECONOMIZER

For recovery of flue gas heat and transfer to a liquid.

EXPLORE OUR WORK

THE STAR – FRISCO, TX

“THE STAR” IS A 91-ACRE CAMPUS THAT HOSTS THE WORLD TRAINING HEADQUARTERS FOR THE DALLAS COWBOYS.

The Project:

With ENERVEX, AES and Texas Air Systems DFW, they designed and installed a high-efficiency chimney system for its new boilers. The design, which common vents all boilers and water heaters to the outside, uses three chimney exhaust systems in three different sizes and six exhaust fans for chimney systems and intake air.

ENERVEX Solution:

One 30" PowerStack® EPS1 air supply system • Two TDF620 inline Power Venters • Two SFTA18 air supply fans • One 20" PowerStack EPS1 air supply system • One IPVB400 Inline Power Venter • One SFTA18 air supply fan • One 12" PowerStack EPS1 for the fireplace systems.



DOHA OASIS IN DOHA, QATAR

The Project:

At 4,500,000 sqft, Doha Oasis is one of the most audacious schemes of recent times. This mixed-use project comprises a 30-story tower; a 4-story basement with cinema, shopping mall, parking and a spacious theme park with rollercoaster; a 12-story range of apartments and a 350 foot-long elliptical park. ENERVEX helped design eight complicated exhaust systems for the project's eight emergency generators in the basement. The systems could not be seen by residents and visitors.

ENERVEX Solution:

Almost 3,000 feet of EPS2 Chimney System ranging in diameter from 18" to 24". Custom made parts included: Excessive Pressure Relief Valves, Flip Tops, Bellows, Pant-Leg Bellows etc. The systems were designed to terminate in special architectural shafts at the building's public front and back.

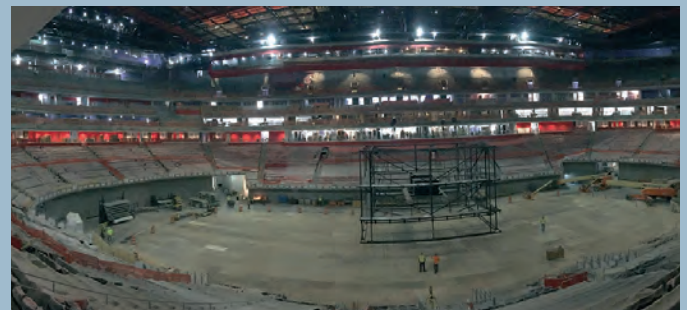

LITTLE CAESAR'S ARENA IN DETROIT

The Project:

Part of a \$650 million mixed-use development, Little Caesars Arena is Detroit's newest sports and entertainment complex hosting the Detroit Red Wings. They needed to common vent six Cleaver-Brooks Clearfire condensing appliances 150 feet in a 36" Special Gas Vent to the outside through a large parking garage. This, while still providing a perfect draft and the desired boiler efficiency. Reps at Mechanical Resource Group and ENERVEX Michigan teamed up to design a listed, fully integrated commercial venting and draft control system.

ENERVEX Solution:

PowerStack® EPS1 Chimney System with six 16" connectors & one 36" common stack • TDF-620 Power Venter inline fan

Six 16" Modulating Overdraft Dampers • Seven EBC30 Modulating Controllers to monitor & maintain pressure

ENERVEX: THE INDUSTRY'S TRUE INNOVATOR

INDUSTRY FIRSTS

ENERVEX is the most innovative supplier of mechanical draft systems in the world. While others are simply adding a façade to existing products, ENERVEX is creating original innovations that have a purpose. Since introducing the industry's first chimney fan in 1958, ENERVEX continues to bring industry-first innovation to the market:

- (1991)
MODULATING MECHANICAL DRAFT SYSTEMS
- (1995)
MODULATING COMBUSTION AIR SUPPLY SYSTEMS
- (2006)
TRUE INLINE MECHANICAL DRAFT FANS
- (2011)
FAN-POWERED FLUE GAS ECONOMIZERS
- (2013)
INLINE FLUE GAS ECONOMIZER WITH MODULAR HEAT EXCHANGER SYSTEMS
- (2015)
ULTRA-ENERGY EFFICIENT, PERMANENT MAGNET MOTORS; STANDARD IN MOST FAN PRODUCTS
- (2015)
SINGLE UNIVERSAL CHIMNEY SYSTEMS LISTED FOR VIRTUALLY ALL VENTING APPLICATIONS
- (2015)
HIGH-TEMPERATURE, PRESSURE- AND LEAK-RESISTANT GRAPHITE GASKETS FOR SEALING FAN/CHIMNEY JOINTS
- ONLY SUPPLIER WITH A 5-YEAR PERFORMANCE & LEAKAGE GUARANTEE**

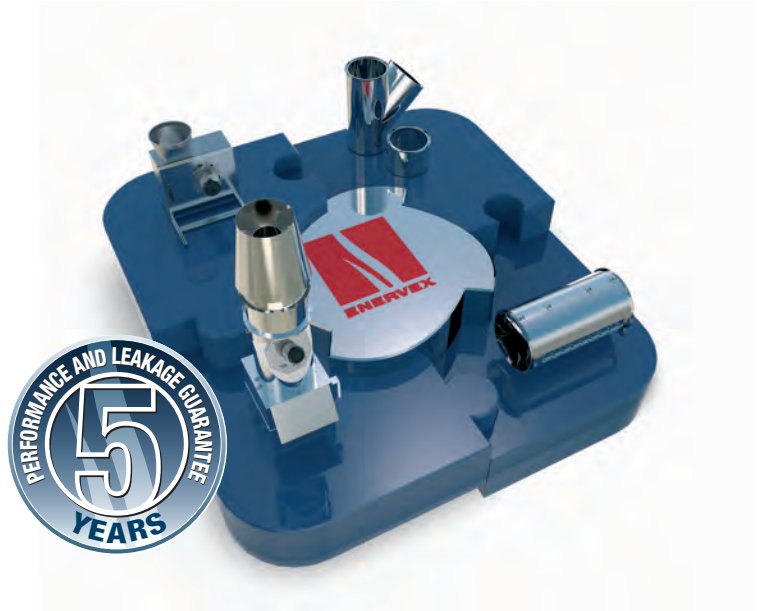

WHY ENERVEX

Every ENERVEX solution is built from the ground up with careful evaluation of the unique cost variables and long-term savings. Through superior manufacturing innovation and decades of experience, we're delivering highest-quality, listed and certified venting solutions that are:

- ECONOMICAL.** Up to 10% fuel savings & 90% lower energy consumption - plus space, materials & labor savings.
- PLUG-AND-PLAY.** One-stop design offers seamless installation, flexibility & confidence that everything will fit together.
- SUSTAINABLE.** Low-energy installations, better indoor air quality; active participant of green building initiatives around the globe.
- AESTHETICALLY PLEASING.** Smaller footprint & design flexibility; put air louvers/terminations where you want.
- SAFE & RELIABLE.** Tested, listed and certified materials means no code problems from boiler outlet to chimney termination.
- GUARANTEED.** One supplier to call for the entire system, backed by the industry's only 110% performance guarantee.

LEARN MORE

Find out how ENERVEX's innovative mechanical draft systems can benefit your next project. Call us or visit ENERVEX.COM now.

ENERVEX Inc.
1685 Bluegrass Lakes
Parkway
Alpharetta, GA 30004
USA

P: 770.587.3238
F: 770.587.4731
T: 800.255.2923
info@enervex.com
www.enervex.com

ENERVEX® 
VENTING DESIGN SOLUTIONS