





EBC 30 Modulating Pressure Control

USA

CAN



-  **Product Information Chapter 1 + 2**
-  **Mechanical Installation Chapter 3**
-  **Electrical Installation Chapter 4**
-  **Start Up and Configuration Chapter 5**
-  **Maintenance and Troubleshooting Chapter 6**



Job Name: _____

Installer: _____

Installation Date: _____

READ AND SAVE THESE INSTRUCTIONS!

1. Product Information	
1.1 Function	3
1.2 Shipping	3
1.3 Warranty.....	3
1.4 EBC 30 Control Components.....	3
2. Specifications	
2.1 Dimensions & Capacities.....	5
3. Mechanical Installation	
3.1 Location.....	6
3.2 Mounting of Control.....	6
3.3 Mounting of Transducer	7
3.4 Installation of Stack Probe (if applicable)	7
3.5 Installation of Outdoor Pressure Probe (if applicable).....	8
4. Electrical Installation	
4.1 General	9
4.2 Relay Board Connections	10
4.3 Triac Board Connections.....	10
4.4 Wiring of XTP2 Sensor.....	11
4.5 Wiring of the Control for Priority Operation.....	11
5. Startup and Configuration	
5.1 Sequence of Operation	12
5.2 Pre-Operation Inspection	13
5.3 Key Panel Identification and Operation.....	13
5.4 Initiation of Control	14
5.5 Basic Control Set-up	14
5.6 Detailed Control Programming.....	16
5.7 Programming Sequence	17
6. Maintenance and Troubleshooting	
.....	18

Symbol Legend:

The following terms are used throughout this manual to bring attention to the presence of potential hazards or to important information concerning the product.



Danger: Indicates an imminent hazardous situation which, if not avoided, will result in death, serious injury or substantial property damage.



Caution: Indicates an imminent hazardous situation which, if not avoided, may result in personal injury or property damage.



TO REDUCE THE RISK OF FIRE, ELECTRICAL SHOCK OR INJURY TO PERSONS, OBSERVE THE FOLLOWING:

1. Use this unit in the manner intended by the manufacturer. If you have questions, contact the manufacturer at the address or telephone number listed on the front of the manual.
2. Before servicing or cleaning the unit, switch off at service panel and lock service panel to prevent power from being switched on accidentally.
3. Installation work and electrical wiring must be done by a qualified person(s) in accordance with applicable codes and standards.
4. Follow the appliance manufacturer’s guidelines and safety standards such as those published by the National Fire Protection Associations (NFPA), and the American Society for Heating, Refrigeration and Air Conditioning Engineers (ASHRAE), and the local code authorities.
5. This unit must be grounded.

How to use this manual

This installation manual does not contain any system design documentation. System design documentation is available from any authorized ENERVEX representative.

Accessories, fans and variable frequency drives are not covered by this manual. Please refer to these component’s individual manuals.



1. Product Information

1.1 Function

- Use** The EBC 30 is a true PID-based fan speed control used to maintain a constant pressure or draft in a venting system. It can be used with RSV, RSIF, RSIB, IPVB, BESF, BESB and SFTA models to control single phase, 120VAC, motors directly and three-phase, 208-460VAC, motors indirectly via a VFD (variable frequency drive) that adjusts the motor speed.
- The intended use of the control includes, but is not limited to:
- Controlling combustion air supply system.
 - Controlling the draft in mechanical draft system serving individual or multiple heating appliance systems.
 - Controlling the damper position in a Modulating Over-Draft System to ensure proper draft is maintained in individual or multiple heating appliance systems.
 - Controlling the duct pressure in dryer venting systems.
 - Controlling the duct pressure in ventilation systems.
- The EBC 30 can simultaneously control an exhaust fan, an intake fan or a draft damper. Any two of these can be controlled simultaneously or they can be controlled individually.
- Use of the control is not restricted to any type of fuel or type of heating appliance, dryer or venting application. The unit features “Plug-and-Play” to automatically monitor all terminals and register components attached to the control during initial start-up. It comes pre-programmed from the factory, but can be further programmed in the field, if needed. The control will allow continuous or intermittent operation of a mechanical draft fan.
- The control has an integrated safety system to assure the heating appliance will shut down in case of fan failure or control failure. A unique Priority Operation function will probe the operating conditions and allow as many appliances as possible to operate without fan assistance, provided the operation is considered safe by the integrated safety system. The EBC 30 has six (6) heating appliance interlock circuits as standard but can be expanded in multiples of four (4) with the use of an additional relay board or the ES 12, Relay Control.
- The control utilizes a high-precision pressure transducer which has a self-auditing feature that will also assure the heating appliance will shut down in case of transducer failure.
- See Chapter 5.1 for the control’s sequence of operation.
- The control can be operated with a manual reset function (reset button) or an automatic reset function. A self-diagnostic panel with LED’s monitors all connection terminals for easy service and troubleshooting. The EBC 30 can also operate in manual mode where the user sets the constant speed. Provided the integrated safety system is satisfied, interlocked heating appliances are allowed to operate.
- A Bearing Cycle Activation function rotates the fan motor(s) once every 24 hours in case the fan has not been operating during the previous 24 hour period.
- Listings** The EBC 30 is tested and listed to the Standard for Industrial Control Equipment, UL Standard 508, 17th Ed. and CSA C22.2 No. 14-95 as well as UL378, Standard for Draft Equipment. It is listed as part of an ENERVEX CASV Chimney Automation System, MCAS Modulating Combustion Air-Supply System, MODS Modulating Over-Draft System and a MDVS Mechanical Dryer Venting System

1.2 Shipping

The EBC 30 contains the following:

- | | | |
|--------------------------|--------------------------|------------------------------|
| • EBC 30 control unit | • Relay board (optional) | • Pressure transducer (XTP2) |
| • Triac board (optional) | • Silicone tubing | • Stack probe |
| | | • User manual |

1.3 Warranty

Complete warranty conditions are available from ENERVEX, Inc.

1.4 EBC 30 Control Components

The EBC 30 control is built up around a main board that controls all basic functions. In addition, a Triac board and a relay board, are available for special functions. The main board controls draft/exhaust and air supply/intake functions. It can provide 0-10VDC signals for Variable Frequency Drives (VFDs), an actuator or other devices accepting a 0-10VDC control signal. It also allows interlock of up to 6 appliances for control circuit voltages between 12VAC and 240VAC/12VDC and 240 VDC, and has an integrated Proven Draft Switch (PDS) function. An external PDS is therefore not required.

The main board layout is shown below in Fig. 1:

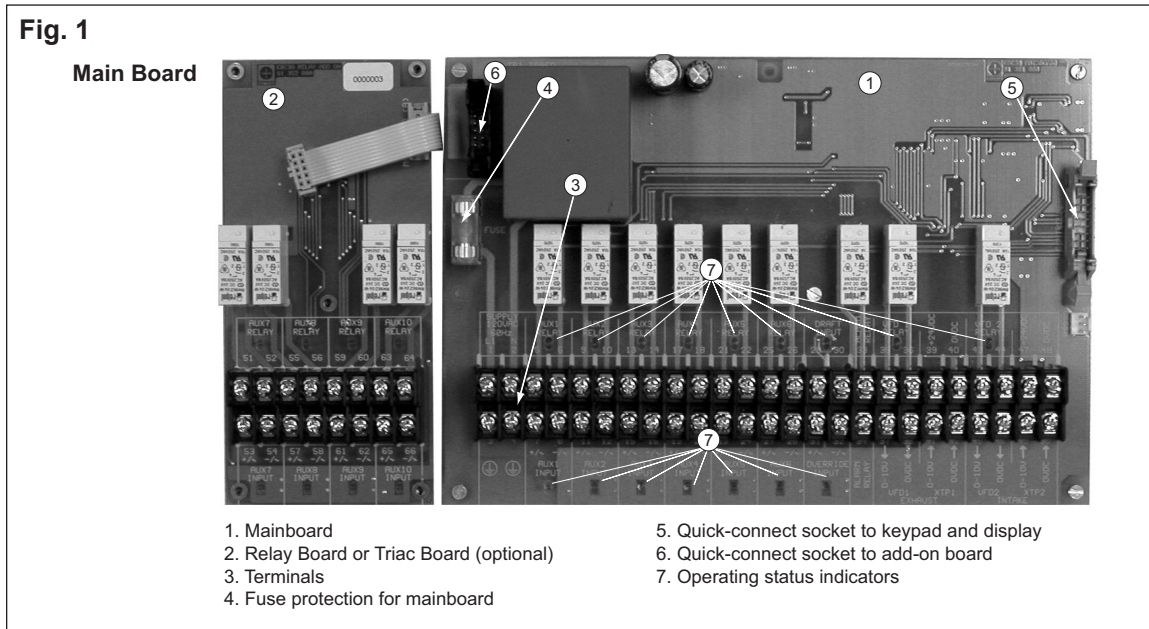

Two add-on boards are available. A Triac board is available so the control can operate a 1x120V fan or ventilator without the need for an external drive. A Relay Board is available for applications with more than 6 appliances. The control can only accept a single add-on board at a time. If there is a need for using the Triac board as well as the Relay board, install the Triac in the EBC 30 and use an ES 12, Relay Box in lieu of the Relay Board. Board layouts for the Triac and the Relay Boards are shown below in Fig. 2:

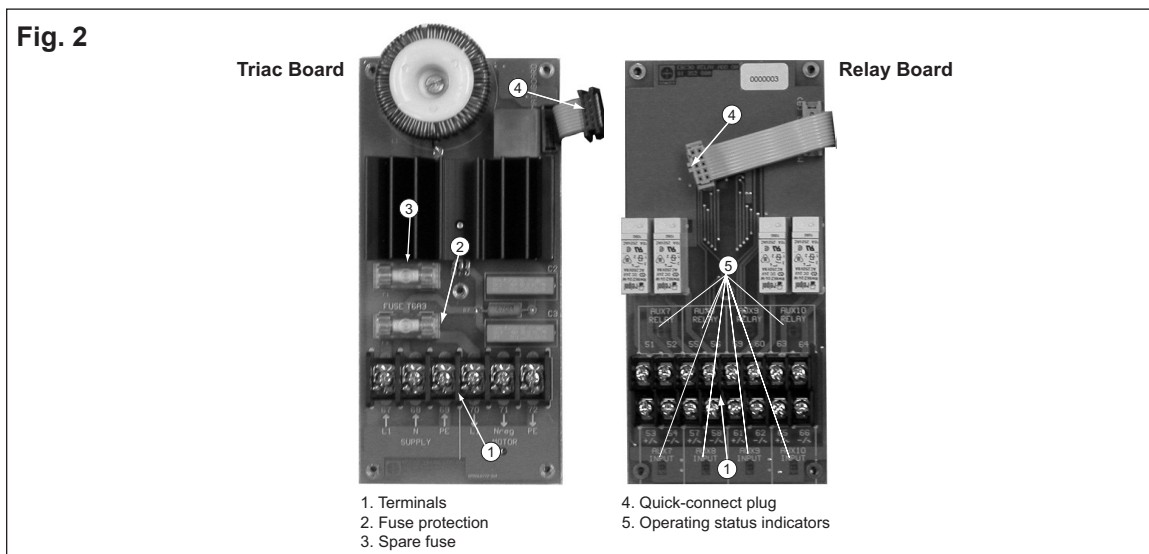

2. Specifications

2.1 Dimensions & Capacities

EBC 30 Control		
Power Supply	V	1x120VAC
Amperage	A	6.3
Operating Temperature	°F/°C	-4 to 122/-20 to 50
Range of Operation	inWC/Pa	0-0.6/0-150
Tolerance	inWC/Pa	0.01/3 +/-10%
Control Signal	mA	max. 10
Control Relay		Max. 120 VAC/8A
Output	VAC	10-120
	VDC	0-10
Dimensions	A in/mm	14.65/372
	B in/mm	11.03/280
	C in/mm	4.22/107
Weight	lbs/kg	8.9/4.0
EMC Standard	Emission	EN 50 081-1
	Immunity	EN 50 082-2
XTP2 Sensor		
Power Supply	VDC	12-36
Amperage	mA	<20
Output	VDC	0-10
Operating Temperature	°F/°C	0 to 160 / -18 to 71
Accuracy	inWC/Pa	+/- 0.08%
Dimensions	D in/mm	3.70 / 94
	E in/mm	5.12 / 130
	F in/mm	6.18 / 157
	G in/mm	3.13 / 80
Weight	lbs/kg	.6/3
Chimney Probe		
Dimensions	H in/mm	4.25/108
	I in/mm	3.50/89

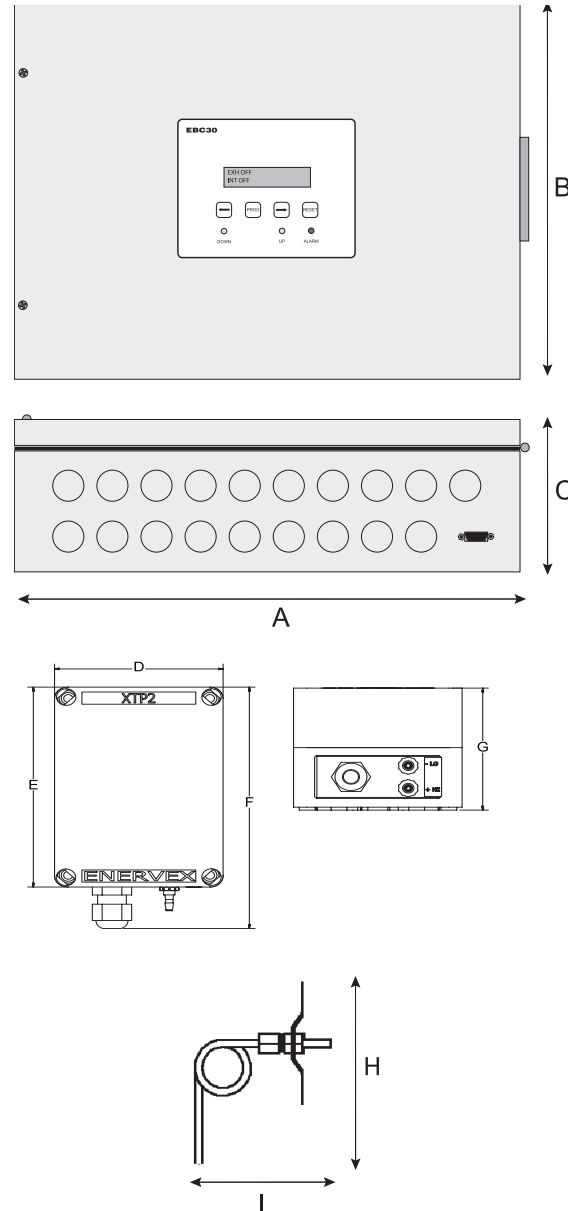



3. Mechanical Installation

3.1 Location

The control and the transducer must be installed inside, preferably in the mechanical room (boiler room). The control does not need to be installed in an enclosure. Fig. 3 shows how the components are connected.



The transducer cannot be mounted inside an airtight enclosure. It uses the boiler room pressure as reference pressure.

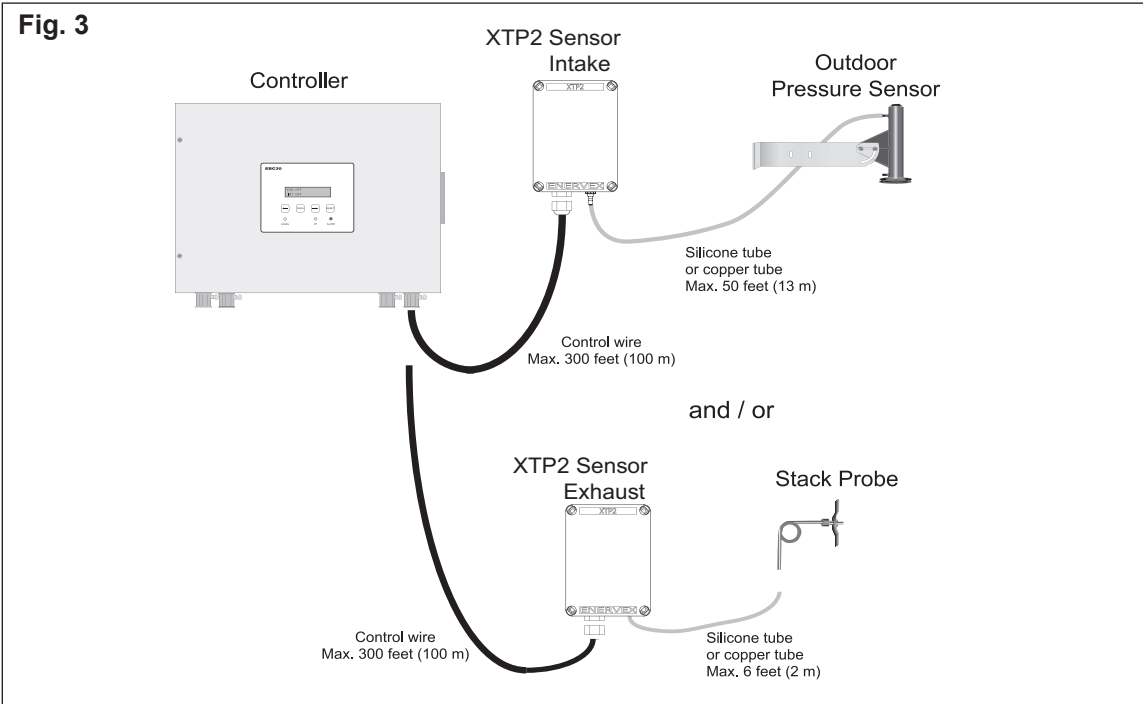

3.2 Mounting of Control

The control can be mounted directly on a wall or similar. The mounting holes are located inside the control as shown in Fig. 4. The distance between the control and the transducer should not exceed three hundred (300) feet.

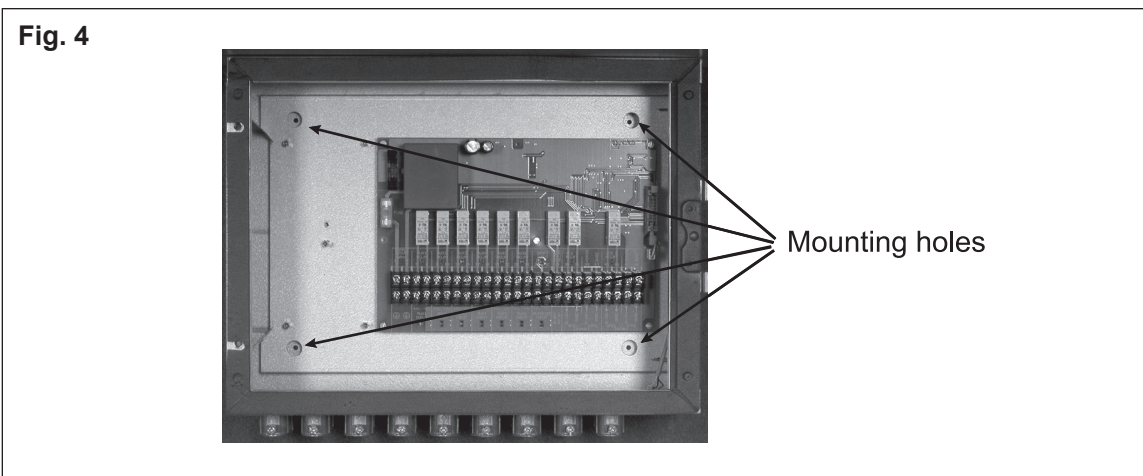

3.3 Mounting of Transducer

Attention must be paid to the position and location of the transducer. Fig. 5 shows the required position. Failure to follow this instruction may result in an inoperable system.

An XTP2 Sensor used for sensing draft should be mounted within six (6) feet of the stack probe.

An XTP2 Sensor used for sensing room pressure should be mounted within fifty (50) feet of the Outdoor Pressure Probe.

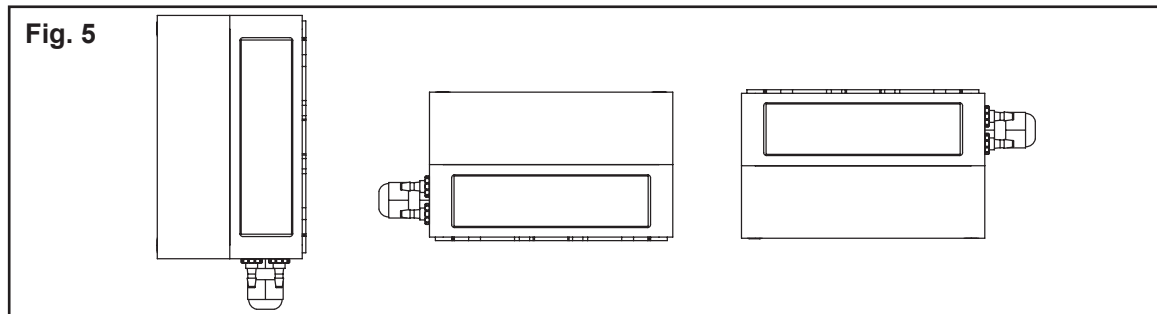

3.4 Installation of Stack Probe (if applicable)

The probe (page 5) is inserted into the chimney or stack at the point where the draft should be kept constant. This could be at the appliance outlet, in the vent or similar. Use a 1/4" drill bit to drill a hole in the side of the chimney for the probe. Acceptable positions are shown below.

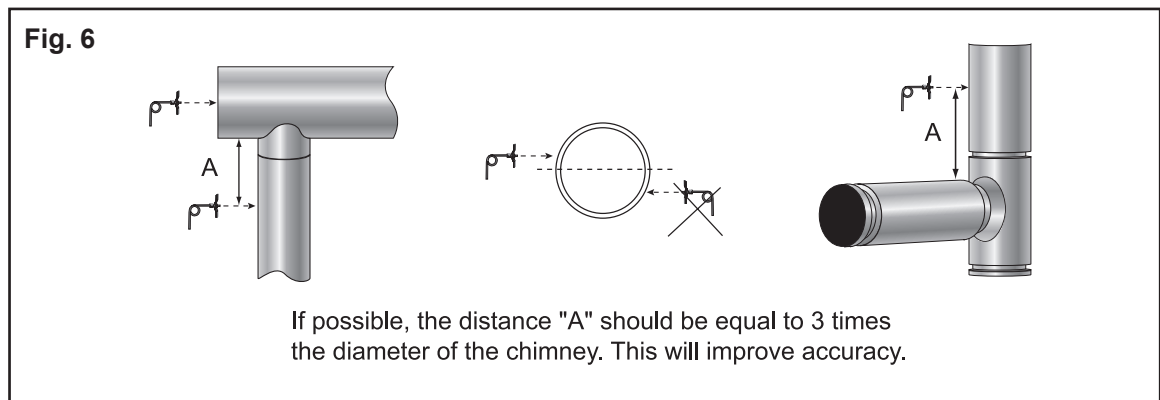

Connect the stack probe to the transducer using the silicone tube. Make sure the tube is connected to the proper transducer port as shown in Fig. 7.

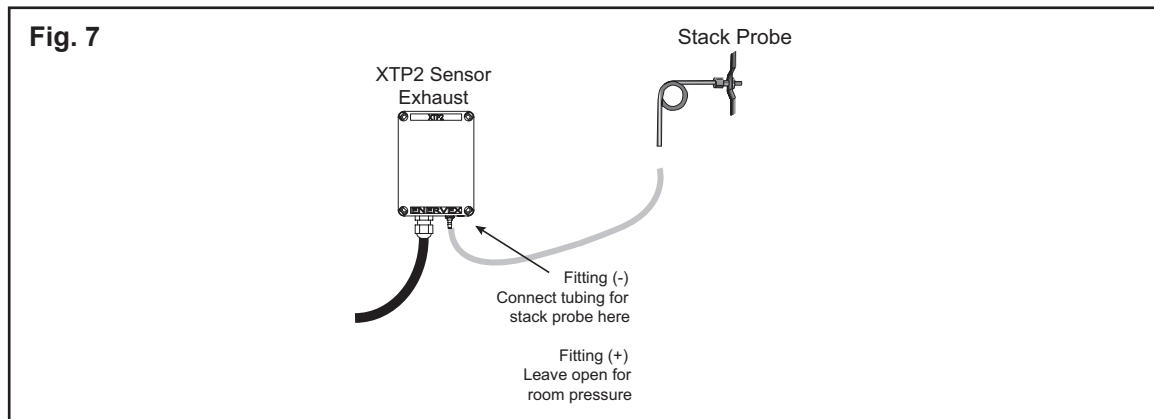

3.5 Installation of Outdoor Pressure Probe (if applicable)

The outdoor pressure probe should be mounted in a location as free as possible from rooftop obstructions. The choice of location should also consider routing of silicone tubing into the building to minimize tubing run on the roof.

Install the probe on an existing structure like a pole, radio or TV antenna mast. Alternately, the “L” shaped bracket can be attached directly to any wall or rooftop.

It is recommended that the full length of tubing (50 feet) be used. Excess tubing should be coiled at some convenient location rather than be cut off. Longer lengths are available.



Obstructions such as trees, chimneys, signs and buildings can cause turbulence, which result in abnormal and thus inaccurate static pressure. Position the probe as far from the sources of turbulence as possible.

The XTP2 sensor is connected to the outdoor pressure probe as shown below in Fig. 8.

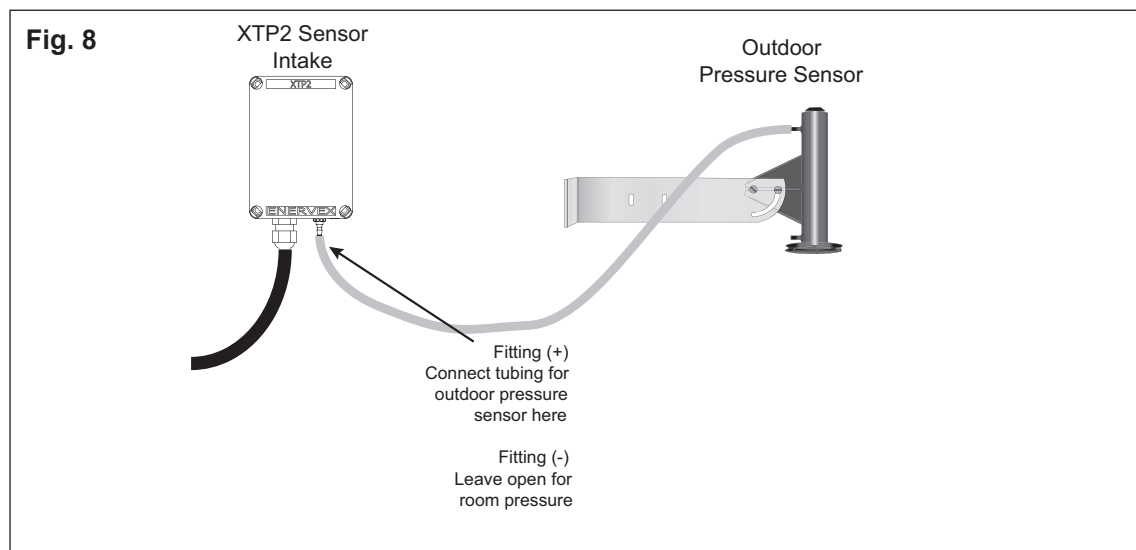

4. Electrical Installation

4.1 General



Danger: Turn off electrical power before servicing. Contact with live electric components can cause shock or death.



EBC 30 is designed for 1x120VAC power supply only. Fan output is regulating on the neutral side and cannot be connected to other circuits.

The terminals are connected as shown (for additional information go to Chapter 5.1):

Terminal	Use
1	Power Supply-L1 (Phase)
2	Power Supply-N (Neutral)
3, 4	Ground
5, 6	AUX1 Dry Contact (Normally Open) Output to Appliance 1 (0-250V, 8A)
7	AUX1 Input - Boiler 1 Thermostat Input 10-250VAC/DC (Load, Pos.)
8	AUX1 Input - Boiler 1 Thermostat Input (Common, Neg.)
9, 10	AUX2 Dry Contact (Normally Open) Output to Appliance 2 (0-250V, 8A)
11	AUX2 Input - Boiler 2 Thermostat Input 10-250VAC/DC (Load, Pos.)
12	AUX2 Input - Boiler 2 Thermostat Input (Common, Neg.)
13, 14	AUX3 Dry Contact (Normally Open) Output to Appliance 3 (0-250V, 8A)
15	AUX3 Input - Boiler 3 Thermostat Input 10-250VAC/DC (Load, Pos.)
16	AUX3 Input - Boiler 3 Thermostat Input (Common, Neg.)
17, 18	AUX4 Dry Contact (Normally Open) Output to Appliance 4 (0-250V, 8A)
19	AUX4 Input - Boiler 4 Thermostat Input 10-250VAC/DC (Load, Pos.)
20	AUX4 Input - Boiler 4 Thermostat Input (Common, Neg.)
21, 22	AUX5 Dry Contact (Normally Open) Output to Appliance 5 (0-250V, 8A)
23	AUX5 Input - Boiler 5 Thermostat Input 10-250VAC/DC (Load, Pos.)
24	AUX5 Input - Boiler 5 Thermostat Input (Common, Neg.)
25, 26	AUX6 Dry Contact (Normally Open) Output to Appliance 6 (0-250V, 8A)
27	AUX6 Input - Boiler 6 Thermostat Input 10-250VAC/DC (Load, Pos.)
28	AUX6 Input - Boiler 6 Thermostat Input (Common, Neg.)
29	Draft Input - Supply to EXTERNAL switch (24 VDC)
30	Draft Input - Return from EXTERNAL switch (24 VDC)
31	Override Input - (positive) - 0-250VAC/DC
32	Override Input - (common)
33, 34	Alarm Relay - Dry Contact (Normally Open) Close on Alarm Condition, (0-250VAC, 8A)
35, 36	VFD1 Relay - Dry Contact (Normally Open) for Exhaust (0-250V)
37	Output to Exhaust VFD1 - (positive) 0-10V
38	Output to Exhaust VFD1 - (common)
39	Power Supply to Exhaust Transducer (positive) - 24VDC
40, 42	Output to Exhaust Transducer - (common)
41	Input from Exhaust Transducer - (positive) 0-10V
43, 44	VFD2 Relay - Dry Contact (Normally Open) for Intake (0-250V)
45	Output to Intake VFD - (positive) 0-10V
46	Output to Intake VFD - (common)
47	Power Supply to Intake Transducer (positive) - 24VDC
48, 50	Output to Intake Transducer - (common)
49	Output to Intake Transducer - (positive) 0-10V

Fig. 9

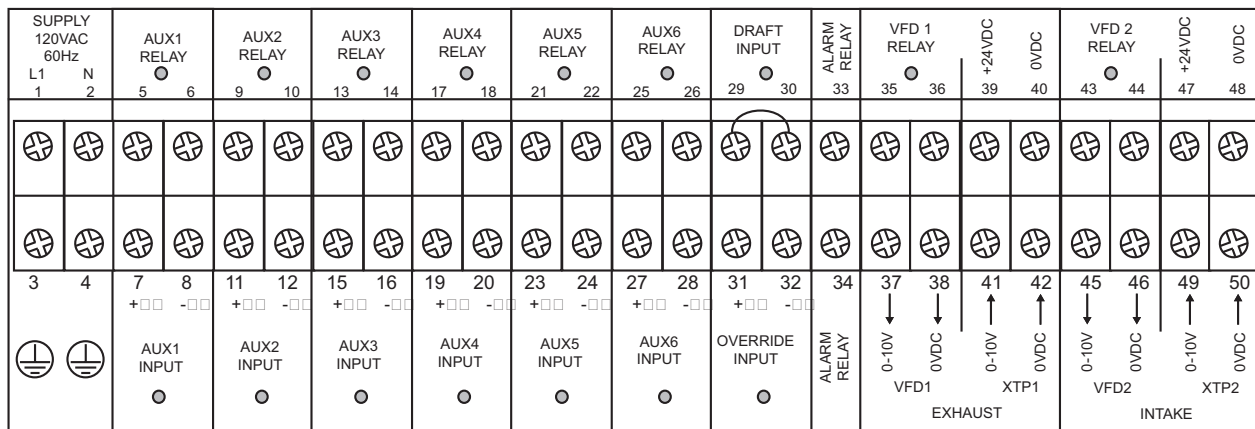

4.2 Relay Board Connections

If the optional Relay Board is used, the control can handle up to 10 appliances.
 Connect the multi plug from the add-on board to the mainboard as show below in Fig. 10.

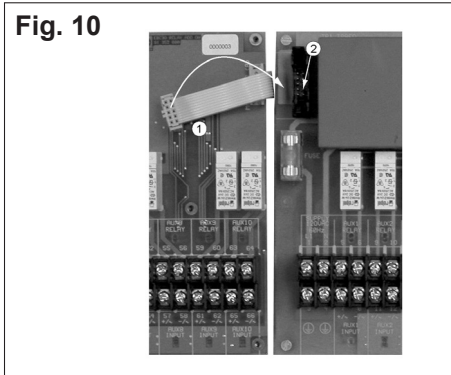

Connect the terminals as needed. The terminal layout is shown in Fig. 11:

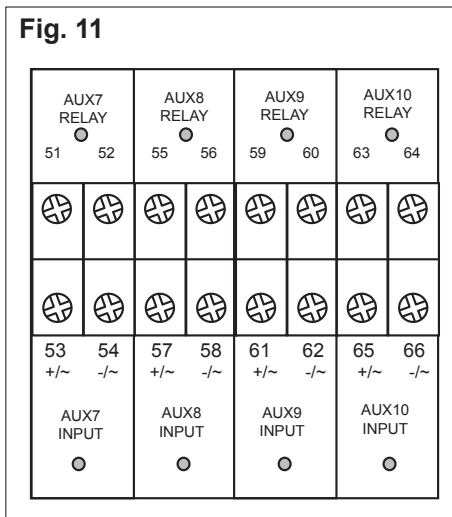

Terminal	Use
51, 52	AUX7 Dry Contact (Normally Open) Output to Appliance 7 (0-250V, 8A)
53	AUX7 input - Boiler 7 Thermostat Input 10-250VAC/DC (Load, Pos.)
54	AUX7 input - Boiler 7 Thermostat Input (Common, Neg.)
55, 56	AUX8 Dry Contact (Normally Open) Output to Appliance 8 (0-250V, 8A)
57	AUX8 input - Boiler 8 Thermostat Input 10-250VAC/DC (Load, Pos.)
58	AUX8 input - Boiler 8 Thermostat Input (Common, Neg.)
59, 60	AUX9 Dry Contact (Normally Open) Output to Appliance 9 (0-250V, 8A)
61	AUX9 input - Boiler 9 Thermostat input 10-250VAC/DC (Load, Pos.)
62	AUX9 input - Boiler 9 Thermostat Input (Common, Neg.)
63, 64	AUX10 Dry Contact (Normally Open) Output to Appliance 10 (0-250V, 8A)
65	AUX10 input - Boiler 10 Thermostat Input 10-250VAC/DC (Load, Pos.)
66	AUX10 input - Boiler 10 Thermostat Input (Common, Neg.)

4.3 Triac Board Connections

If the optional Triac Board Add-On is used, the control can control fans operating at 1x120VAC. **IMPORTANT:** If both Exhaust and Intake functions are used, the Triac Board defaults to Intake, but the control can be programed to operate the Triac Board for the Exhaust function as well.

Connect the multi plug from the add-on board to the mainboard as shown in Fig. 10.
 Connect the terminals as needed. The terminal layout is shown in Fig. 12.

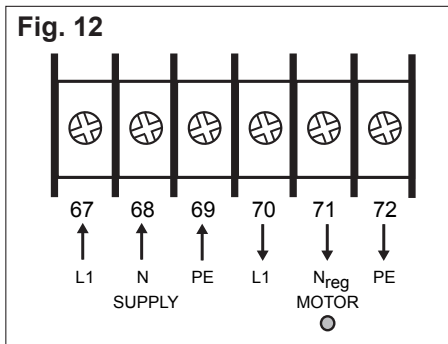

Terminal	Use
67	Power Supply - L1 (Phase) - 120VAC
68	Power Supply - N (Neutral)
69	PE (Ground)
70	Fan Motor Supply - L1 (Phase)
71	Fan Motor Supply - Nreg (Neutral)
72	PE (Ground)



Fan output is regulating on the neutral side and cannot be connected to other circuits.

4.4 Wiring of XTP2 Sensor

The XTP2 sensor is wired as shown below. The wiring to the XTP2 sensor is always the same, while the wiring on the EBC 30 control depends on whether it is to be wired for exhaust or intake operation:

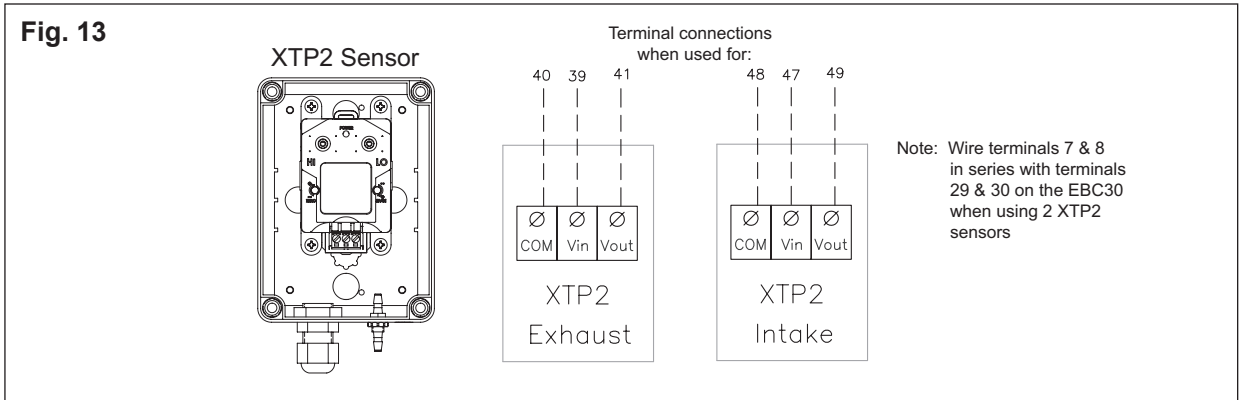

4.5 Wiring of the Control for Priority Operation

The control features Priority Operation, which is used only in case of a power failure or mechanical failure at the fan location. The feature will automatically evaluate if one or more appliance(s) can operate safely without mechanical draft. This function is constantly monitored by the PDS function and only if the min. draft point is satisfied, will operation be allowed.

On a call for heat, the control will first probe the appliance connected to the AUX1 Input AUX1 Relay terminals, secondly the appliance connected to the AUX2 Input/AUX2 Relay terminals and so on.

Consider the operating priority of the appliances when wiring to the control.

List appliance priority here:

Priority	Appliance Type or Number	Connects to terminals
1	_____	AUX1 - Input/Relay
2	_____	AUX2 - Input/Relay
3	_____	AUX3 - Input/Relay
4	_____	AUX4 - Input/Relay
5	_____	AUX5 - Input/Relay
6	_____	AUX6 - Input/Relay

In case the highest priority appliance is not operating and a low priority appliance calls for heat, the control will allow the low priority appliance to operate.



5. Startup and Configuration

5.1 Sequence of Operation

The EBC 30 initializes when 120VAC power is supplied. It checks for the presence of integrated components such as add-on boards and pressure sensors. The Control does not detect Variable Frequency Drives or Damper Actuators.

- The software version is displayed on the LED screen
- The control checks for intake and exhaust application by sensing current drawn by an Intake or Exhaust XTP properly connected. It then displays Found or Not Found for Exhaust and Intake modes
- The control checks for any add-on modules and displays Relay Found, Triac Found, or Nothing Found.
- The EBC 30 system application is displayed as Intake Only, Exhaust Only, or Intake and Exhaust.
- The differential pressure reading will be (+) or (-) in reference to the type of pressure being maintained. The pressure reading will be displayed to the hundredths decimal place. The display reads 'NOT USED' when an XTP2 Sensor is not connected.

Intermittent Operation

In Intermittent Operation, both AUX Input and AUX RELAY connections are made between each appliance and the EBC 30. This allows the Control to start and stop the fan when an appliance is attempting to fire, and to prevent the appliances from operating if proper draft is not met.

- The EBC 30 initiates pressure control when a voltage signal from any of the six appliances is sensed at the AUX INPUT terminals. No electrical path connects the AUX INPUT terminals so no current passes between them. The LED between the AUX INPUT terminals lights when a call for heat voltage is sensed.
- The Control sends a 100% output to the controlled fans in the system via the Fan Control Module for 120VAC fans or the VFD1 (exhaust) or VFD2 (intake) 0-10VDC outputs for 3 phase fans controlled by Variable Frequency Drives.
- The XTP2 senses the draft between the exhaust stack and the room or between the outsideair and the room and send a 0-10VDC signal back to the XTP1 (exhaust) or XTP2 (intake) terminals.
- The current pressure reading is displayed on the EBC 30. It displays INT or EXH then the pressure reading or both if the application is Intake and Exhaust.
- The DRAFT INPUT terminals must be closed by an external Proven Draft Switch or by a manually installed jumper before any appliances are allowed to operate.
- The AUX RELAY contacts will close only for the appliances that are calling for heat when Draft Set Point pressure is met and DRAFT INPUT is closed. When the AUX RELAY closes, the LED between the terminals will light and the appliance will be permitted to operate normally.
- The EBC 30 will individually close the AUX RELAY contacts for other appliances as they call for heat via their AUX INPUT connections while proper draft is maintained.
- The AUX RELAY contacts will open for individual appliances if their AUX INPUT voltage is lost, or open all AUX RELAYS if the draft is not met or no appliance calls for heat.

The EBC 30 modulates draft pressures by increasing or decreasing the fan speed in response to changing pressure signals. The pressure shown on the display is always in inches of water column of relative vacuum draft.

- The Exhaust fan increases speed to increase the draft felt by the appliances.
- The Intake fan increases speed to decrease the draft read on intake only systems.
- Fan speed is controlled by the 0 to 10VDC output signals at VFD1 & VFD2 terminals where 10VDC is maximum speed.
- The Fan Control Module sends 0 to 120VAC to control single phase fans when they are used. The FCM defaults to control the Intake fan when both Intake and Exhaust applications are used.

If the EBC 30 draft reading is out of acceptable range (64% deviation) for 15 seconds, the control will go into Alarm status and open all of the AUX RELAY contacts that shut down the appliances. When draft is met again, it will function as stated above. The control will also go into alarm immediately when the XTP150G detects an internal failure.

Continuous Operation

For Continuous Operation, Dip Switch 1 & 2 on the back of the display card on the EBC 30 door must be in the Up / On position. AUX INPUT connections are not used since the Control always attempts to maintain the pressure set point regardless of appliance status. The AUX INPUT LEDs remain lit in Continuous operation and all other EBC 30 functions remain the same as in Intermittent Operation.

5.2 Pre-Operation Inspection

After mounting and wiring has been completed, check the control for the following items before applying power:





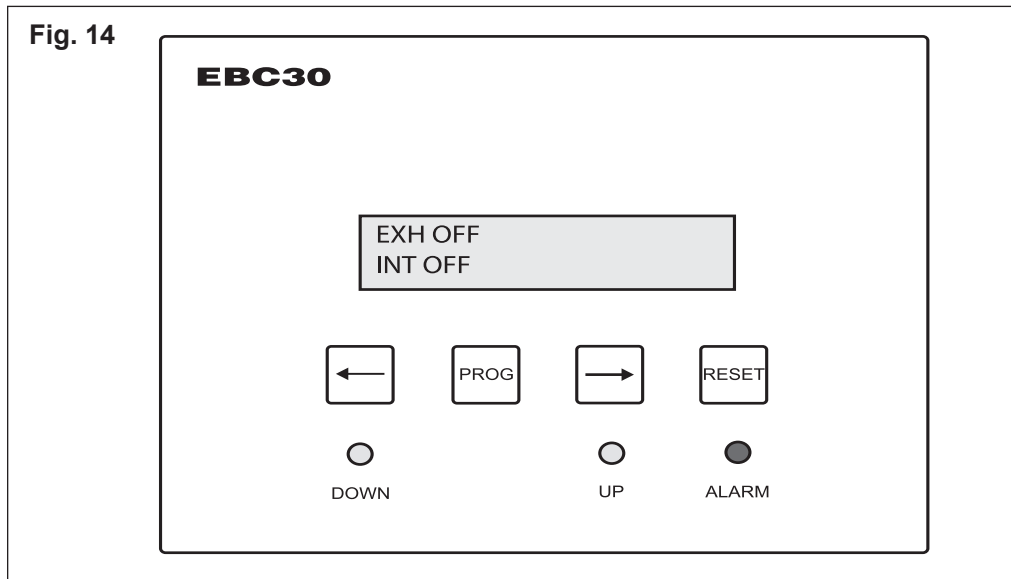

- Check for wiring errors.
- Verify that there are no wiring chips, screws, etc. remaining inside the controller.
- Check that all screws and terminal connections are tight.
- Verify that no exposed wire ends are touching other terminals.

5.3 Key Panel Identification and Operation

When AC power is applied to the control, the keypad panel display will show the following:



The keypad part names and functions are:

- | | |
|---|---|
|  | PROGRAM KEY. Used to access the menu - press for 3 seconds to get to the Quick-menu. |
|  | RESET KEY. Key used for resetting control and fault codes. Also used to accept programming changes and exit the programming mode. |
|  | DOWN KEY. Used to decrease the value of a parameter. |
|  | UP KEY. Used to increase the value of a parameter. |
|  | DECELERATION INDICATOR. When yellow light is lit, it indicates decreasing fan speed. |
|  | ACCELERATION INDICATOR. When yellow light is lit, it indicates increasing fan speed. |
|  | ALARM INDICATOR. When red light is lit, it indicates an error that must be corrected. |

5.4 Initiation of Control

When power is supplied to the control it will go through a start-up procedure to detect and check all components and appliances installed. During this procedure the display will show the following:

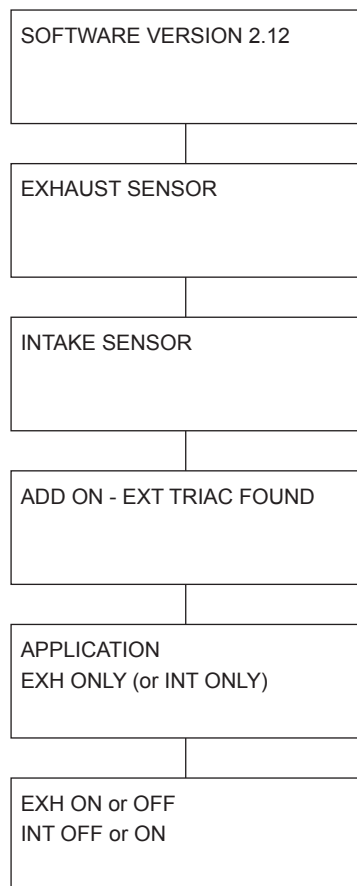

The control is ready. The major functions can now be programmed using the Quick-menu.

5.5 Basic Control Set-up

Once power is turned ON the control can be programmed. Most parameters are programmed at the factory and do not need to be changed. There are 9 parameters that can be programmed/set prior to operation, and they can be accessed through the Quick-Menu.

Q1 SET EXHAUST

For setting the draft or exhaust pressure. Although the value, when measured in the field, is negative pressure it shows up as a positive value on the display. The lowest possible value is 0.012 inWC. Most applications require a setting in the range of 0.012 inWC to 0.100 inWC. Atmospheric appliances (Category I) are always in the low range, while all other appliances can be anywhere.

The %-value indicates the relative setting of the total range of the sensor.

There is no need to set this value, if the control is used to control the supply of combustion air.

Q2 EXHAUST OPERATING MODE

The control can operate the fan(s) in either “continuous” or “intermittent” mode. The mode can be changed via the display. The display only shows the chosen mode. The mode can be overridden by the dipswitches inside the cover on the print board. If switches are all in ON positions the control will act as there were a call for heat for all appliance at all times. This will disable pre-purge, post-purge and prime functions. This is a function that is beneficial for MODS, MCAS operations and for testing/troubleshooting.

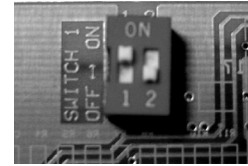

In “continuous” mode the fan operates continuously. During times when the heating appliance(s) is not operating, the fan will still operate although at its lowest capacity. Some exhaust will be pulled through the appliance. The chimney is always primed and there is no real need for pre- and post-purge functions. The energy consumption in this mode is minimal.

In “intermittent” mode the fan only operates if at least one appliance is operating. When no appliance(s) is operating the fan shuts down. In this mode, pre- and post-purge functions are very important and must be set. This mode offers the lowest energy consumption.

If a heating system operates constantly, or the time between cycles is very short (less than 5-10 minutes), “continuous” mode should be considered. Otherwise, “intermittent” mode should be selected.

There is no need to set this value, if the control is used to control the supply of combustion air.

If used with a damper actuator, set for continuous operation.

Q3 SET EXHAUST PRE-PURGE

When operating in “intermittent” mode it is important to set the pre-purge. Pre-purge is the period from when there is a call for heat until the control allows the appliance to start assuming the fan is operating at the proper capacity. The setting can be anywhere from 0 to 1800 seconds.

There is no need to set this value, if the control is used to control the supply of combustion air.

Q4 SET EXHAUST POST-PURGE

When operating in “intermittent” mode it is important to set the post-purge. Post-purge is the period from when the appliance shuts down until the control allows the fan to shut down assuming there are no more products of combustion in the chimney system. The setting can be anywhere from 0 to 1800 seconds.

There is no need to set this value, if the control is used to control the supply of combustion air.

Q5 SET INTAKE

For setting the room pressure. The lowest possible value is 0.012 inWC. Most applications require a setting of 0.012 inWC.

The %-value indicates the relative setting of the total range of the sensor.

There is no need to set this value, if the control is used to control the draft or exhaust pressure.

Q6 INTAKE OPERATING MODE

The control can operate the fan(s) in either “continuous” or “intermittent” mode. The display only shows the chosen mode. See also Q2 about the dipswitch, which can be very beneficial for the supply of combustion air or make-up air, especially where there are chillers, fans etc. that consume air. In “continuous” mode the supply fan operates continuously. During times when the heating appliance(s) is not operating, the supply fan will still operate although at its lowest capacity. Some pressurization of the mechanical room may occur. The room is always primed and there is no real need for pre- and post-purge functions. The energy consumption in this mode is minimal.

In “intermittent” mode the supply fan only operates if at least one appliance is operating. When no appliance(s) is operating the supply fan shuts down. In this mode, pre- and post-purge functions are very important and must be set. This mode offers the lowest energy consumption.

If a heating system operates constantly, or the time between cycles is very short (less than 5-10 minutes), “continuous” mode should be considered. Otherwise, “intermittent” mode should be selected.

There is no need to set this value, if the control is used to control the draft or exhaust pressure.

Q7 SET INTAKE PRE-PURGE

When operating in “intermittent” mode it is important to set the pre-purge. Pre-purge is the period from when there is a call for heat until the control allows the appliance to start assuming the supply fan is operating at the proper capacity. The setting can be anywhere from 0 to 1800 seconds. There is no need to set this value, if the control is used to control the draft or exhaust pressure.

Q8 SET INTAKE POST-PURGE

When operating in “intermittent” mode it is important to set the post-purge. Post-purge is the period from when the appliance shuts down until the control allows the fan to shut down assuming there are no more products of combustion in the chimney system. The setting can be anywhere from 0 to 1800 seconds. There is no need to set this value, if the control is used to control the draft or exhaust pressure.

Q9 ROTATION CHECK

There are two values available “ON” or “OFF”.

In the ON mode, the control will activate all fans connected to the control when turned on, and operate them at a very low speed so proper rotation can be easily verified when 3-phase motors are used. If improper rotation is experienced appropriate action can be taken. Once proper operation has been verified, press the RESET button to accept all settings.

The above procedure is only required during the initial installation or if a motor or variable frequency drive has been replaced.

If a power failure has occurred there is no need to check rotation and the RESET button can be pressed.

In the OFF mode, the control does not activate all fans in low speed mode but will let them operate at any speed setting. OFF mode can be used after the initial installation.

To access the Quick-Menu, press the PROG key for 3 seconds. The figure on page 16 shows the sequence of programming.

5.6 Detailed Control Programming

The EBC 30 control has a detailed sub-menu for individual parameter settings. See page 19 for more details on parameters and programming.

To view current alarm description inside service menu press  and it goes to parameter 51 “current alarm” (if alarm condition is present). Must go to “5 alarm” to exit.

5.7 Programming Sequence

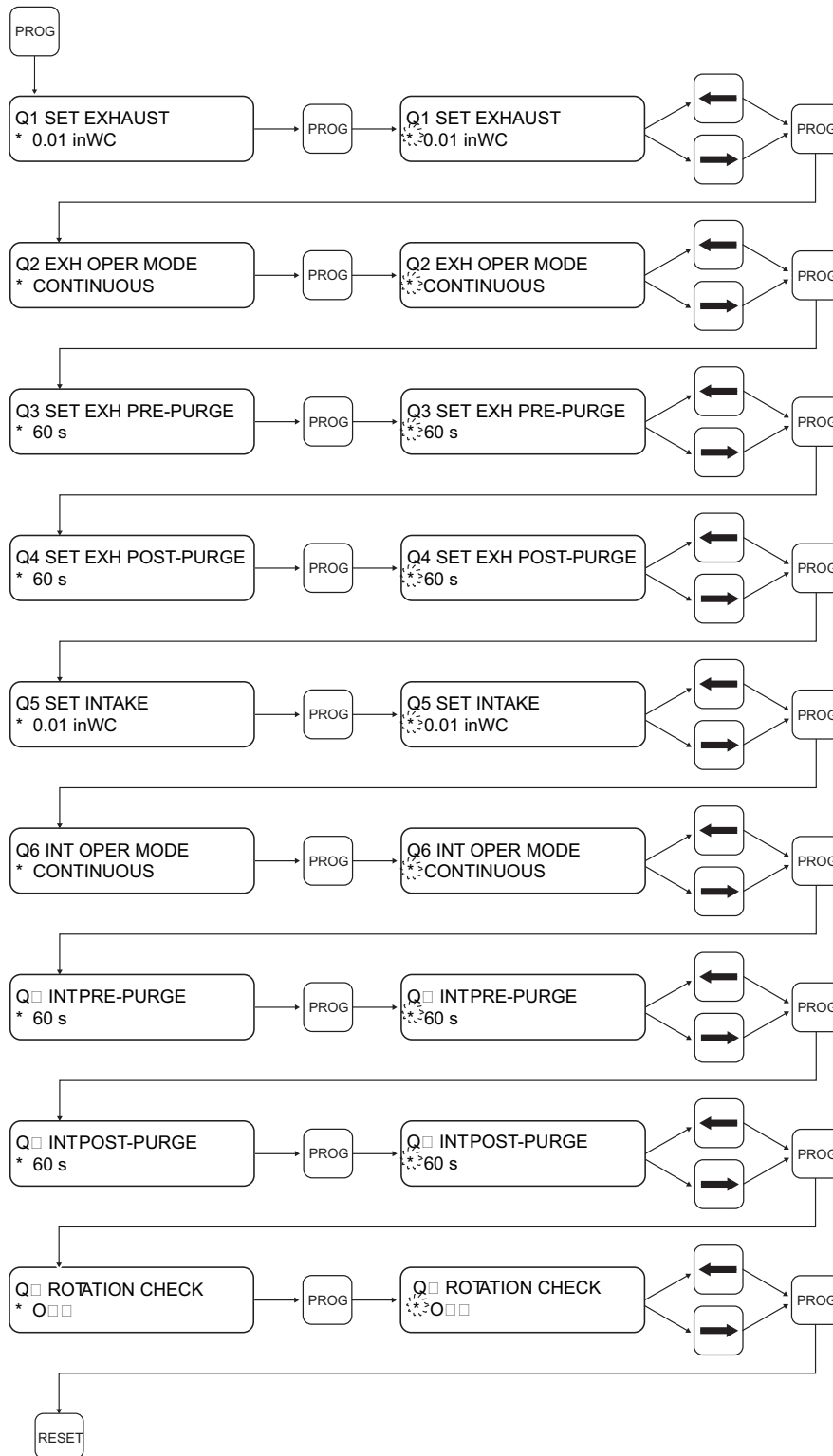

NOTES

P□□ss □□□ □□□ 3 s□□□n□s
□□ □□□□ss □□□□

T□□ □□□□ss□□□□ □□n □□ s□□
□□□□□□n 0.012 □n□ 0.5□6
□D□□□□□□ is 0.012□

A□□i□□□□□□ s□□□□□□i□ns □□
□□□n□in□□□□s□ □n□ □in□□□

□□□□□s □□n □□ s□□ □□□□ (□
360 s□□□□n□s.

□□□□□s □□n □□ s□□ □□□□ (□
360 s□□□□n□s.

T□□ □□□□ss□□□□ □□n □□ s□□
□□□□□□n 0.012 □n□ 0.5□6
□D□□□□□□ is 0.012□

A□□i□□□□□□ s□□□□□□i□ns □□
□□□n□in□□□□s□ □n□ □in□□□

□□□□□s □□n □□ s□□ □□□□ (□
360 s□□□□n□s.

□□□□□s □□n □□ s□□ □□□□ (□
360 s□□□□n□s.

□□□□□s □□n □□ ON □□ O□□

S□□□□s □□□ s□□□□in□s □n□
□is□□□□□s □□□□□□□□ □is□□□



6. Maintenance and Troubleshooting

Most terminal connections are monitored for proper operation. LED lights indicate operating status. If a light is lit, it indicates everything is functioning properly while a light out indicates a problem on the circuit it monitors.

In addition, fault codes are shown on the display. The fault codes are:

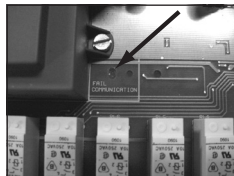
Display	Explanation
A1 Draft Exhaust	Insufficient draft pressure. Can be caused by: <ol style="list-style-type: none"> 1. Chimney fan does not have enough capacity 2. Mechanical or electrical fan failure 3. Blocked chimney 4. Introduction of excessive dilution air 5. XTP2 Sensor not responding correctly
A2 Draft Intake	Insufficient intake air supply. Can be caused by: <ol style="list-style-type: none"> 1. Supply fan does not have enough capacity 2. Mechanical or electrical fan failure 3. Blocked air inlet our louver 4. Excessive exhaust from exhaust fans located in mechanical room
A3 Power Fault	Indicates there has been a power fault
A4 XTP-Exhaust	Indicates a disconnected signal from the XTP-Sensor on the exhaust side to the control. Can be caused by: <ol style="list-style-type: none"> 1. Loose connections 2. Faulty XTP2 Sensor 3. Faulty controller
A5 XTP-Intake	Indicates a disconnected signal from the XTP-sensor on the intake side to the control. Can be caused by: <ol style="list-style-type: none"> 4. Loose connections 5. Faulty XTP2 Sensor 6. Faulty controller
A6 Error Start	Indicates that the control has not been able to release the heating appliance(s) within 15 minutes.
A7 Alarm Override	Indicates alarm has been ignored
A8 Draft Input	Missing signal from PDS-function. Indicates a faulty function.
Other fault possibilities are shown below:	
Red alarm on main board is lit	Indicates a malfunction. Can be caused by: <ol style="list-style-type: none"> 1. No communication between main board and display. <p>Make sure the cable is connected. This error will shut down the appliances within 20 seconds.</p> 
Red alarm diode flashes	Indicates the control operates the appliances in prioritized mode.
Yellow light (UP) is lit continuously	Indicates the control is accelerating the fan speed. If it stays on constantly it indicates a system fault. This can be caused by <ol style="list-style-type: none"> 1. Wiring problems 2. A clogged tube or probe 3. A leaking chimney system 4. Inadequate fan capacity
Yellow light (DOWN) is lit continuously	Indicates a malfunction. Can be caused by: <ol style="list-style-type: none"> 1. If a Triac Board is installed this is an indication that the neutral connection is shared with other equipment. It must be a dedicated line between the control and the fan.

EBC 30 Factory Settings

Menu	Sub-Menu	Function	Display	Range	Default
2		EXHAUST	EXHAUST		
	21	Draft Set Point	SET EXHAUST	3%-95% of sensor range	0.100
	22	Operation Mode	OPERATION	Continuous / Intermittent	Intermittent
	23	PRE-PURGE	PREPURGE		0
	231	Time	TIME	0-1800	0
	232	Operation Mode	SPEED MODE	Variable / FIX 20%-100%	FIX 100 %
	24	POST-PURGE	POST PURGE		
	241	Time	TIME	0-1800	0
	242	Operation Mode	SPEED MODE	Variable / FIX 20%-100%	Variable
	25	SENSOR	SENSOR		
	251	Min. Pressure	RANGE MIN	-500-+500Pa	0
	252	Max . Pressure	RANGE MAX	0-1000Pa	150Pa
	26	PARAMETERS	PROPERTIES		
	261	Alarm Limit Draft	ALARM LIMIT	50-80%	64%
	262	Alarm Delay	ALARM DELAY	0-120s	15
	263	Min. Voltage	SPEED MIN	0-MENU264	15%
	264	Max. Voltage	SPEED MAX	MENU263-100%	100%
	265	Xp	EXHAUST Xp	0-30	15
	266	Ti	EXHAUST Ti	0-30	8
	267	Pressure Type	PRESSURE MOD	(+) or (-)	Negative
3		INTAKE	INTAKE		
	31	Intake Set Point	SET INTAKE	3%-95% of sensor range	0.016
	32	Operation Mode	OPERATION	Continuous / Intermittent	Intermittent
	33	PRE-PURGE	PREPURGE		
	331	Time	TIME	0-1800	0
	332	Operation Mode	SPEED MODE	Variable / FIX 20%-100%	Variable
	34	POST-PURGE	POST PURGE		
	341	Time	TIME	0-1800	0
	342	Operation Mode	SPEED MODE	Variable / FIX 20%-100%	Variable
	35	SENSOR	SENSOR		
	351	Min. Pressure	RANGE MIN	-500-+500Pa	0
	352	Max . Pressure	RANGE MAX	0-1000Pa	150Pa
	36	PARAMETERS	PROPERTIES		
	361	Alarm Limit Draft	ALARM LIMIT	100-300%.	300%
	362	Alarm Delay	ALARM DELAY	0-120s	15s
	363	Min. Voltage	SPEED MIN	0-MENU364	10%
	364	Max. Voltage	SPEED MAX	MENU363-100%	100%
	365	Xp	INTAKE Xp	0-30	15
	366	Ti	INTAKE Ti	0-30	8
	367	Pressure Type	PRESSURE MOD	(+) or (-)	Negative
4		DISPLAY	DISPLAY		
	41	Language	LANGUAGE	Eng / Fr. / Sp.	English
	42	Units	UNIT	Pa / inWC	inWC
	43	Display Lights	LIGHT	ON / OFF	ON
5		ALARM			
	51	Alarm status	ERROR		
	52	Alarm log	ERROR LOG		
	53	RESET	RESET	MAN / AUT	AUT
6		SERVICE	SERVICE		
	61	Version No.	VERSION		
	62	I/O	I/O-VIEW		
	621	BURNER I/O*	AUX OUT XXX XXX		
	622	RELAY BOARD*	RELAY OUT XXXX		
	623	EXHAUST I/O*	EXH XTP x.xV OFF		
	624	INTAKE I/O*	INT XTP x.xV OFF		
	625	TRIAC BOARD	TRIAC BOARD		
	626	DRAFT INPUT	DRAFT INPUT		
	627	Override input	OVERRIDE IN		
	628	Alarm Relay	ALARM OUTPUT		
	629	Application	APPLICATION		
	63	Triac board	TRIAC BOARD	INTAKE/ EXHAUST	
	64	OVERRIDE	OVERRIDE		
	641	Draft Mode	EXHAUST	OFF / NORMAL / MAX	MAX
	642	Intake Mode	INTAKE	OFF / NORMAL / MAX	NORMAL
	643	Alarm Mode	ALARM MODE	ON / OFF	OFF
	65	OPTIONS	OPTION		
	651	Prioritized Duty	PRIORITY	ON / OFF	OFF
	652	Bearing Activation	BEARING CYCLE	ON / OFF	ON
	653	Allow Prime	ALLOW PRIME	1-250S / OFF	OFF
	65	FACTORY RESET	FACTORY	YES / NO	NO

Resetting to Factory Defaults

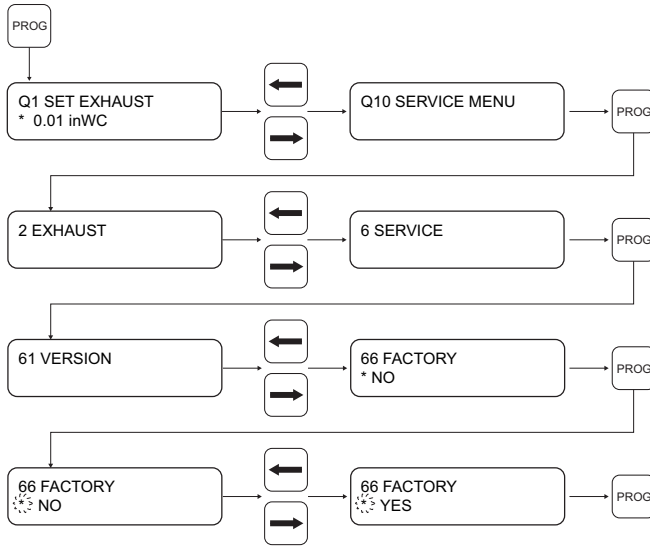

NOTES

Press PROG key for 3 seconds to access menu

Scroll to [Q10 SERVICE MENU] and press PROG

Scroll to 6 SERVICE and press PROG

Scroll to 66 FACTORY and press PROG

Change NO to YES and press PROG

Remove supply power to control. Wait 30 seconds and reapply power. Control is now reset to factory default.

User Settings

Please record and keep the following information. It will ease servicing the control after installation.

Q1 EXHAUST setting	_____ "WC
Q2 EXHAUST Operating Mode	Continuous/Intermittent (<i>circle one</i>)
Q3 EXHAUST Pre-purge	_____ seconds
Q4 EXHAUST Post-purge	_____ seconds
Q5 INTAKE setting	_____ "WC
Q6 INTAKE Operating Mode	Continuous/Intermittent (<i>circle one</i>)
Q7 INTAKE Pre-purge	_____ seconds
Q8 INTAKE Post-purge	_____ seconds
Q9 ROTATION CHECK	Yes/No (<i>circle one</i>)